

# HOW TO CORNER YOURSELF WITH GREAT SOUND

Introduction to Cornered C6TRM, C6, C5 & C4

CORNERED AUDIO®

Contents of the manual are subject to change without notice. CORNERED Audio does not accept any liability for loss or damage caused or alleged to be caused directly or indirectly by these instructions. CORNERED Audio makes no guarantee of any kind with regard to these instructions.

# Contents

---

## **INTRODUCTION**

Welcome to CORNERED speakers

## **GETTING STARTED**

1. Connect the cables
2. Find the perfect spot
3. Mount the speakers

## **DAILY USE OF YOUR SPEAKERS**

A powerful experience  
Cleaning and maintenance  
Disposing of electrical appliances

## **NOTES FOR THE PROFESSIONAL INSTALLER**

## **INSTALLING THE SPEAKER**

## **SPECIFICATIONS**

Warranty & service

## **DECLARATION OF CONFORMITY**

---

# Congratulations!

You are up for a great looking and great sounding experience

With the purchase of your CORNERED speakers, you can enjoy two things in one: Unique design and excellent sound.

CORNERED speakers feature a one-of-a-kind 90-degree triangular design that makes for a discreet and elegant installation anywhere in your home - in corners, on the wall, below the ceiling, on shelves and as a center and rear channel for surround sound.

But good looks aren't everything. CORNERED speakers also offers excellent sound quality. In fact, CORNERED speakers reproduce a natural three-dimensional sound stage that fills your room with sound - and strives at making listening to music one of your favorite activities.

To get the most out of your CORNERED speakers - and make the installation process as easy as possible - please take a minute to study this manual.

Enjoy!



Hans V. Madsen / Founder

---

# Getting started

Follow 3 easy steps to install your new CORNERED speakers, and soon you'll be cornered by sound in a class of its own:

1. Connect the cables
2. Find the perfect spot
3. Mount the speakers

## 1. Connect the cables

*Note:* It is important that you install the speaker cables BEFORE mounting your new CORNERED speakers! The speakers are equipped with discreet cable terminals placed on the front baffle behind the front cover - and it is not possible to run the cables to the terminals once the speakers have been mounted.

- Remove the front cover to access the cable terminal (the front cover is held in place with neodymium magnets) ①
- Make sure the amplifier is turned off
- Run the speaker cable through the tube positioned at the rear of the cabinet. The cable will come out between the woofers on the front plate ②
- Connect the red plus (+) output from the amplifier to the red plus (+) cable terminal located to the right of the tube ③
- Connect the negative minus (-) output from the amplifier to the black minus (-) input terminal located to the left of the tube ③

### *Important notes:*

- The tube allows for cables with a maximum diameter of 10mm
- For the best result, use speaker cables with a wire thickness of min. 1,5mm<sup>2</sup>
- If the red amplifier output is connected to the black speaker input (out of phase), the stereo imaging will be blurred, and the bass output will be dramatically reduced
- Make sure the terminals are screwed down tight after connecting the cables
- Always use the same type of cables for left and right speaker channels

When you have connected the cables to the terminals, pull the cables tight in the tube - and you are ready to mount the speakers.

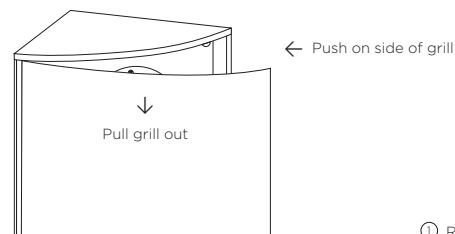

① Remove the front cover

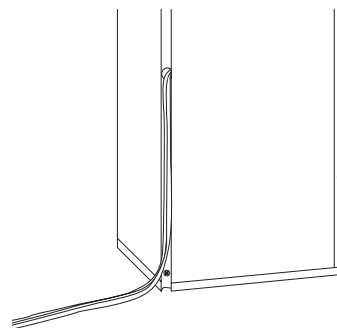

② Run the speaker cable

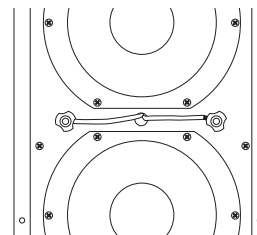

③ Connecting speaker cables

## 2. Find the perfect spot

### Designed for versatile positioning

You've probably already found the perfect place for your new CORNERED speakers! The speakers will fit vertically in a corner, horizontally between the wall and the ceiling, above or below your TV as a center channel and of course behind your couch as rear channels. If you don't feel like mounting the speakers to the wall, you also have the option of placing them like traditional speakers on a shelf or on top of a piece of furniture.

### Create a natural 3D sound stage

CORNERED speakers have a very wide dispersion of sound. To get the most out of the speakers, we recommend as a rule of thumb that you place them with a distance of minimum 2 meters and maximum 5 meters between the left and right speakers. Avoid placing objects such as furniture between the speakers and the listening position, as this will have a negative influence on the tonal balance of the sound. If you take these few precautions, your new speakers will reproduce a natural 3-dimensional sound stage - and give you a clear picture of each of the musicians and their position on the stage.

## 3. Mount the speakers

### Vertical installation

If you prefer to mount the speaker vertically in a corner, you should:

- Remove the front cover (you'll see the mounting holes in the left and right side of the cabinet)
- Place speakers in desired position
- Mark drilling positions on the wall by shading through the 4 mounting holes
- Drill holes in the wall and use 4mm rawlplugs and 3mm screws
- Reposition the speakers in desired position and mount the screws ①
- Reinstall the front cover while ensuring that it is turned so that the cut outs for the woofers are placed over the woofers ②

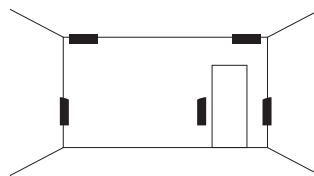

### Application examples Stereo

Vertical in corner  
Vertical on wall  
Horizontal in corner

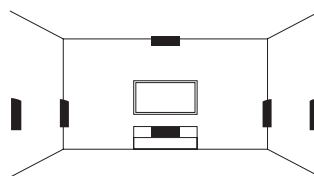

### Application examples Surround

Vertical in corner as front channels  
Vertical on wall as rear channels  
Horizontal below TV  
\*Horizontal above TV

\*If you wish to have the voice coming exactly from the TV screen, you have the possibility of using two centre channels, one below and one above the TV screen.

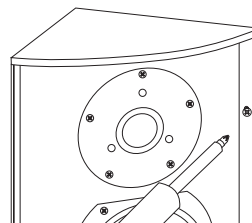

① Mounting the screws

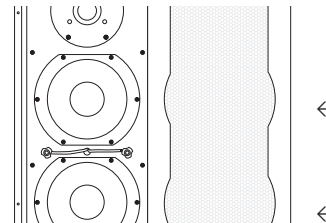

② Reinstall the front cover

### Mounting in corners that are not exactly 90 degrees

Even if the corners in your home are not exactly 90 degrees, you can still mount your new CORNERED speakers in the corner.

- If the corner is less than 90 degrees, simply place the speaker cabinet as deep in the corner as possible and use all four mounting points. This will leave a little space behind the cabinet and the walls, but the speakers will still appear with a nice finish in the corner
- If the corner is more than 90 degrees, we recommend mounting only one of the sides of the speaker cabinet onto the wall - and leave some air behind the rear of the cabinet. This will not be visible from the front, and the speakers will still present themselves with a nice finish in the corner

### Horizontal installation

If you wish to place the speakers horizontally away from the ceiling, you'll need to mount them onto a small bracket. Here's how you do it:

- Remove the front cover
- Place speakers in desired position
- Mark drilling positions on the wall using only the two lower mounting holes
- Drill holes in the wall
- Insert the bracket in the upper mounting holes and mount the bracket to the wall
- Reinstall the front cover

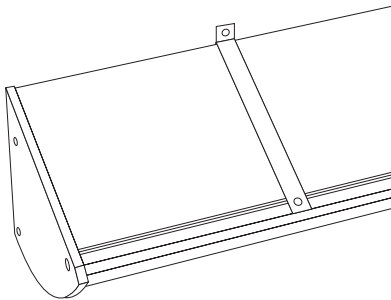

Mounting the bracket

# Daily use of your speakers

## How to get the most out of your speakers

### A powerful experience

There are many cool things about your new CORNERED speakers. Among others, they can play very loud for their size and they are very reliable.

### Choosing a suitable amplifier

Here's the deal: Contrary to what many people think, a small amplifier is a greater risk to the speakers than a big one! The reason being that a small amplifier, if pressed to the limits, might become unstable and produce distortion or clipping.

This will increase the power more than 10 times to the tweeter, which may cause damage. A large amplifier however, will remain in control while playing loud. As long as the signal is clean, the speakers will have no problem receiving slightly more power than they are specified for.

### Important notes:

- The tone controls should be set close to the neutral position
- If you hear distortion or mechanical sounds from the speakers, chances are that your amplifier is overdriven, and volume has to be turned down
- CORNERED speakers have a nominal impedance of 8 ohm - which makes them an easy load for the amplifier and a great match for all quality amplifiers

### Cleaning and maintenance

To keep up the good looks, clean the cabinet with a soft, dry micro-fiber cloth. The front cover can be vacuumed and wiped carefully with a well-wrung, lint-free cloth with a mild all-purpose cleaner. If you need to clean the speakers behind the front cover, avoid wiping the dome tweeter as it can change the geometry of the dome and reduce the sound quality significantly.

### Disposing of electrical appliances

When eventually disposing of the product, do not mix it with general household waste. There is a separate collection system for used electronic products in accordance with legislation that requires proper treatment, recovery and recycling. Private households in the EU member states, Switzerland and Norway may return their used electronic products free of charge to designated collection facilities or to a retailer (if you purchase a similar new one). For countries not mentioned above, please contact your local authorities for the correct method of disposal. By doing so, you will ensure that your disposed product undergoes the necessary treatment, recovery and recycling and thus prevent potential negative effects on the environment and human health.

# Notes for the professional installer

## Installation

### Before installing

As CORNERED top-boxes are very light, make sure that the wall structure is solid and can support the weight of the speaker before installing the speaker. Also, make sure that you comply with all local health and safety regulations.

### A one-person job

The top-boxes are extruded in aluminum and therefore more compact and lighter than a similar wooden cabinet. At the same time, the aluminum cabinet works as a large cooling surface, thus reducing power compression significantly. The low weight allows the products to be installed easily by one person. Drive units and crossover can be easily accessed behind the front cover, which can be removed without tools in a matter of seconds.

### Safety wire

In installation terms, the CORNERED top-boxes are 'as much brackets as they are speakers,' so no safety wire is needed, just as you don't need a safety wire from the wall to a bracket.

## Coverage

### Wide dispersion even at high frequencies

CORNERED speakers are designed with emphasis on uniform and wide power response. Special emphasis is placed on phase through the crossover point and cone/dome geometry. As an example, the large surround of the tweeter dome ensures very wide dispersion also at high frequencies.

- One cabinet offers app 90x90 degree dispersion. Cabinets can be coupled together to increase coverage
- Two CORNERED cabinets can be coupled together back to back and mounted flush onto walls and ceilings while offering 180 degrees of coverage with minimum phase cancellation between the cabinets

- Three cabinets can be mounted together around a corner, offering 270 degree coverage
- And four cabinets can be mounted together and hung from the ceiling, offering 360 degree of dispersion

### Recommended speaker cables

Speaker cables present the amplifier with different loads. Cables with high capacitance, high inductance and high impedance have a strong negative influence on sound quality as well as amplifier reliability. So in order to get the most out of the speaker system, avoid using thin speaker cables.

As a rule of thumb, 2 mm<sup>2</sup> (14 AWG) cable can be used for lengths up to 20 meters. 4 mm<sup>2</sup> (11 AWG) cable should be used for lengths over 20 meters. For lengths over 50 meters, some amplifiers will become unstable and sound quality and reliability will be reduced significantly. Cornered speakers will allow for a 10mm cable to be run through the cable tube, so if you use thick professional installation cable, simply remove the outer isolation material from the cable and run the separate wires to the speaker terminals (provided the cable wires have separate isolation). We recommend the Cornered CSP2 speaker cable designed to fit in corners.

### Easy load

Cornered speakers have high Re min., so they are an easy load. Typical pro amplifiers will run three speakers per channel without problems.

### Recommended amplifier

For professional applications we recommend amplifiers with a minimum output on level with the highest recommended amplifier output in the specifications. If used with a sub, we recommend a 24 dB Linkwitz-Riley high-pass filter at 80 - 100 Hz.

# Installing the speaker

## Installation

### Before installing

Make sure that the wall structure is solid and can support the weight of the speaker. Also, make sure that you comply with all local health and safety regulations.

As the speaker is pre-angled, coverage can be adjusted by positioning the cabinet higher or lower in the room - horizontally or vertically - until the desired coverage is obtained. See below:

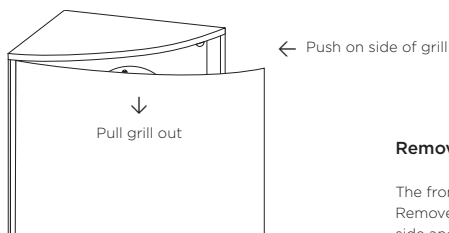

### Remove the front cover

The front cover is fastened with magnets. Remove it by pushing on it from one side and pull it outwards

### Corner position

- 1: Remove front cover
- 2: Mount speaker cable
- 3: Place speaker at desired position
- 4: Mark drilling positions on wall by shading through the mounting holes behind the front cover
- 5: Drill holes in wall
- 6: Reposition speaker at desired position and mount the screws
- 7: Reinstall front cover

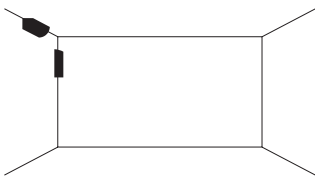

### Vertical on wall away from the corner

1. Remove front cover
2. Mount speaker cable
3. Place speaker at desired position
4. Mark drilling positions on wall using only the mounting holes at one side of the cabinet
5. Drill holes in wall
6. Reposition speaker at desired position and mount the screws
7. Reinstall front cover

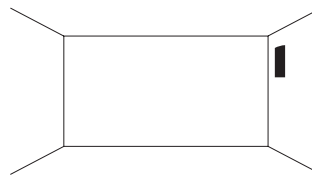

### Two speakers vertical or horizontal on wall or ceiling

1. Remove front cover
2. Mount speaker cables
3. Screw one side of the cabinets together using 9mm bolts with 4mm diameter.
4. Repeat steps 3 to 6 from above.

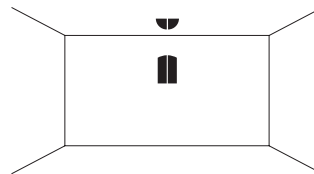

### One speaker horizontal on wall or in "under balcony" applications

1. Remove front cover
2. Place speaker at desired position
3. Mark drilling points on wall using only the mounting points in one side of the cabinet
4. Lower the hook on the bracket into the middle mounting hole in cabinet and pull it towards wall or ceiling.\*
5. Mark mounting position through the bracket screw hole.
6. Drill holes in wall or ceiling
7. Mount the speaker cables
8. Reposition speaker at desired position and screw the cabinet and bracket into the wall or ceiling
9. Reinstall front cover

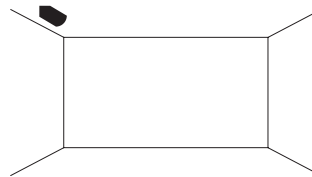
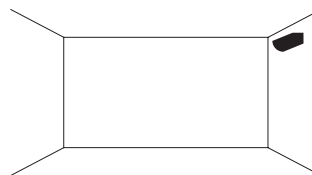

\*How to mount the bracket, please refer to illustration on page 10



# Specifications

## C4

Woofers:	4" + 4" slave
Tweeter:	1" silk dome
Recommended amplifier:	50-120 watt in 8 ohm
Sensitivity:	86 dB
Frequency response:	64 - 25 kHz
Nominal impedance:	8 ohm
Dispersion:	120x120 degree
Binding post:	Screw terminal
Finish:	White, black
Measurement:	(HxWxD) 397mm x 190mm x 124mm
Weight:	3,4 kg

## C5

Woofers:	5 ¼" + 5 ¼" slave
Tweeter:	1" silk dome
Recommended amplifier:	50-150 watt in 8 ohm
Sensitivity:	88 dB
Frequency response:	59-25 kHz
Nominal impedance:	8 ohm
Binding post:	Screw terminal
Dispersion:	120x120 degree
Finish:	White, black, aluminium
Measurement:	(HxWxD) 434mm x 211mm x 137mm
Weight:	4,1 kg

## Warranty & service

For warranty information, please refer to your local CORNERED distributor or dealer. Spare parts for your CORNERED speakers are available through your local CORNERED distributor. In case you are not able to source spare parts locally, please contact us directly at [info@cornered.dk](mailto:info@cornered.dk).

## C6

Woofers:	6 ½"
Tweeter:	1" silk dome
Crossover:	Air coils and poly caps
Recommended amplifier:	100-200 watt in 8 ohm
Sensitivity:	90 dB
Max SPL long term/peak:	111 dB/117 dB
Frequency response:	70-25 kHz
Nominal impedance:	8 ohm
Dispersion:	120x120 degree
Binding post:	Screw terminal
Finish:	White, black, aluminium
Measurement:	(HxWxD) 502mm x 232mm x 155mm
Weight:	5,2 kg

## C6TRM

Woofers:	6 ½" neo
Tweeter:	1" horn loaded
Crossover:	Air coils and poly caps
Recommended amplifier:	150-350 watt in 8 ohm
Sensitivity:	91 dB
Max SPL long term/peak:	115 dB/121 dB
Frequency response:	80-20 kHz
Nominal impedance:	8 ohm
Dispersion:	90x90 degree
Binding post:	Screw terminal
Finish:	White, black, aluminium
Measurement:	(HxWxD) 502mm x 232mm x 155mm
Weight:	5,7 kg

# Declaration of conformity

**Manufacturer:**

CORNERED Audio ApS  
Roskildevej 16A  
2620 Albertslund  
Denmark

We, CORNERED Audio ApS, declare under our responsibility that the following product(s):

C4, C5, C6 & C6TRM  
Type: Speaker

...are in conformity with:

COUNCIL DIRECTIVE of 3 May 1989 on the approximation of the laws of the Member States relating to electromagnetic compatibility (89/336/EEC)

..and has been manufactured in conformity with the following national standards that implements a harmonized standard:

EN 55013

Limits and methods of measurement of radio disturbance characteristics of broadcast receivers and associated equipment.



Hans V. Madsen / Founder  
01.06.2010